

Article number: 203180M20249B1W

Description: E+G levelling foot
GN 31-80-M20-249-B1-W

Note: W With adjustable sleeve , Hygienic Version, Wrench flat at the bottom

Measures

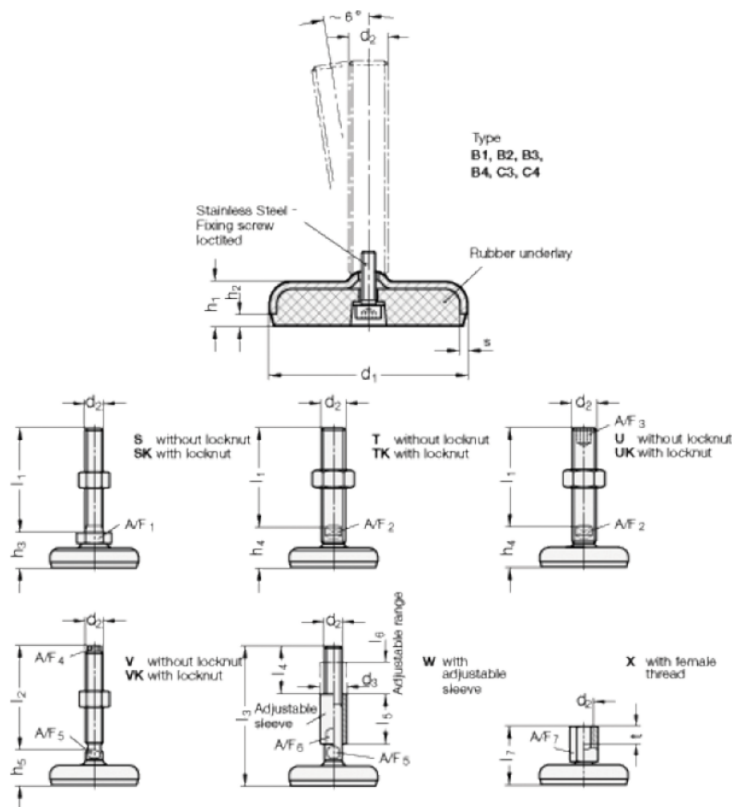

A/F5 = 16	I3 +4.0/0 = 249
A/F6 = 24	I4 = 56
d1 = 80	I5 = 56
d2 = 20	I6 = 36
d3 = 30	s = 3
h1 = 18	
h2 = 5	
I1 = 249	